



MASON INDUSTRIES, Inc.

Manufacturers of Vibration Control Products

350 Rabro Drive
Hauppauge, NY 11788
631/348-0282
FAX 631/348-0279
Info@Mason-Ind.com
www.Mason-Ind.com

2101 W. Crescent Ave., Suite D
Anaheim, CA 92801
714/535-2727
FAX 714/535-5738
Info@MasonAnaheim.com
www.MasonAnaheim.com

BUILDING ISOLATION

SLFJ Spring Isolators
BBNR Rubber Isolation Bearings

Noise and vibration isolators are used to prevent the downward transmission of vibration from a machine to a structure, the upward transfer from the structure to a sensitive machine or to isolate a complete building from ground vibration. Ground vibration may be generated by above ground or under ground passenger or freight trains, or heavy motorized vehicles, such as trucks or military equipment. The source may be industrial hammers, power plants or industrial machines, close enough to cause a problem.

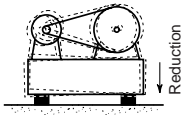

Positive Isolation

When the isolators are installed to prevent the downward flow of vibration from a source to the ground or structure, it is termed "positive isolation". When the reverse is true and the isolators prevent the upward passage of vibration, it is "negative isolation".

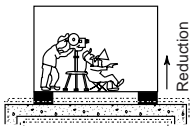

Negative Isolation

Steel springs are more effective, but Neoprene and Natural Rubber pads are also used to reduce vibration to entire structures or structural components such as individual floors or a theater within a building, to levels that are unnoticeable or totally acceptable.

The simplified theoretical isolation efficiency equation is:

$$E = 100 \left[1 - \frac{1}{(fd/fn)^2 - 1} \right]$$

- E** = percentage vibration reduction
- fd** = disturbing frequency
- fn** = Natural or Resonant frequency of the isolated system

Since the disturbing frequency can be measured or from a known source, the variable is the pad frequency or resonance. This frequency is a function of deflection, the shape of the load - deflection curve and dynamic stiffness.

Helical steel springs have straight line load deflection curves and the dynamic stiffness at **fd** is the same as the static stiffness (stiffness when loaded slowly).

If a steel spring were deflected 0.3" (7.6mm), the frequency would be:

$$fn = 3.13 \sqrt{\frac{1}{d}} \text{ or } fn = 3.13 \sqrt{\frac{25.4}{d}} \quad \text{Metric}$$

$$fn = 3.13 \sqrt{\frac{1}{0.3}} \text{ or } 3.13 \sqrt{\frac{25.4}{7.6}} = 5.7 \text{ Hz} \quad \text{d = deflection in inches or mm}$$

fn = frequency in Hertz (Hz) cycles per second

Rubber materials do not test that way because they have "Dynamic Stiffness". When the pad is vibrated, it resists the rapid motion, so the spring rate in motion (dynamic) is higher than the static stiffness indicated on a load versus deflection curve. Dynamic Stiffness is expressed as the ratio:

$$\frac{\text{Dynamic Spring Rate}}{\text{Static Spring Rate}}$$

The static deflection must be reduced by the Dynamic Stiffness ratio before it can be entered in the frequency equation. Therefore, larger static deflections are needed when using rubber isolators as compared to springs, to obtain the same reduction in vibration transmission.

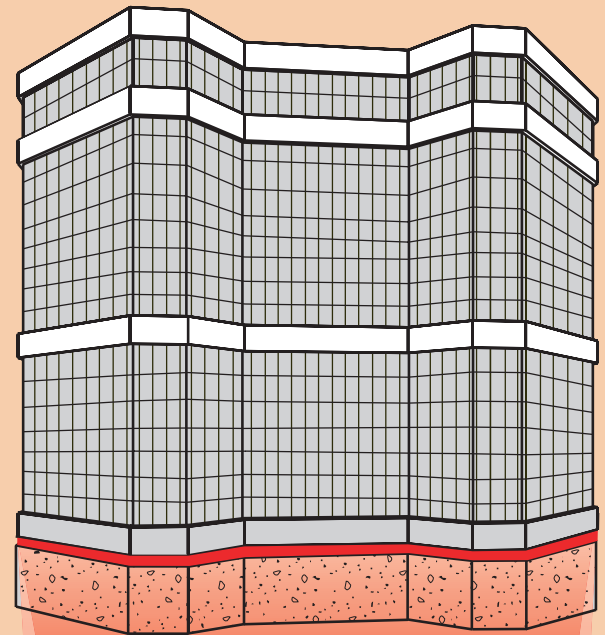

Isolated Structure

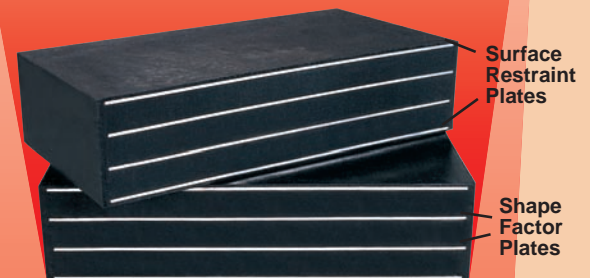

Rubber Bearing Cross Section Type BBNR



Hydraulically Adjusted Spring Isolator Type SLFJ

In broad terms, dynamic stiffness is controlled by:

The Polymer: Natural Rubber has the lowest dynamic stiffness of all the common materials. The synthetic material, Neoprene, comes next. There is virtually no data on other polymers, because they are not used for this purpose.

Filler Ratios: Rubber materials are similar to concrete in the sense that by varying the formula you can produce different properties. When mixing concrete, the reinforcing materials are sand and gravel. In mixing rubber, high quality compounds are reinforced with carbon blacks. The inexpensive compounds with poor physical properties may use cheap fillers like clay, talc and sometimes coal particles. In order to keep dynamic stiffness low, the black fillers are kept to a weight ratio that is never over half that of the Natural Rubber.

Durometer: Harder materials with larger proportion of black fillers will tend to have higher dynamic stiffnesses.

Most acousticians will specify a maximum dynamic stiffness of 1.4 or lower. We are pleased to say that within our company, we have developed compounds as hard as 60 durometer with a dynamic stiffness that is still in the 1.3 range. In working with our company, bearings can be designed at lower cost by using 60 durometer rubber as compared to competitors that might be limited to 50 durometer or softer materials.

If a rubber pad deflected 0.3" (7.6mm) and the dynamic stiffness was 1.3, the effective deflection would be 0.3" divided by 1.3 or 0.23" (5.9mm). Solving the Frequency equation shows a frequency of 6.5Hz. A poorer compound with a dynamic stiffness of 1.7 would reduce the effective deflection to 0.180" (4.6mm) with a corresponding higher frequency.

Load-Deflection Curve Shape: A second correction depends on the shape of the rubber load deflection curve. This curve is not straight line and the measured deflection must be reduced by the effect of the increased spring rate at the design loading.

Creep is additional deflection or drift over time. It is not a percentage of the pad's thickness. Creep is a percentage of the initial deflection and a function of the rubber compound. A working number of 30% creep is reasonable. Were the initial deflection 0.3" (7.6mm), within 100 days the pad would creep 0.30 (0.3) or 0.09" (2.3mm) and for all practical purposes remain at a total deflection of 0.39" (9.9mm). This additional deflection does not reduce the frequency.

When an isolation frequency of 5.5 Hz or higher will solve the problem, rubber isolation pads are more economical than steel springs.

Rubber noise and vibration pads are used in compression at a strain of (deflection) up to 10% of the rubber thickness when supporting structures. Once the desired frequency and dynamic stiffness is known, it is a simple calculation to work back to the deflection. The deflection divided by the strain determines the thickness of the working rubber in the bearing.

Seismic Isolation is accomplished by tall bearings with extremely low horizontal or shear frequencies. Vertical deflection is kept to a minimum as most earthquakes have high horizontal forces, and structures are more prone to horizontal resonance and failure.

Bridge and overpass bearings work in shear to accommodate expansion and contraction. Frequency is not important and plays little or no role in the design. The rubber pad must have a minimum thickness of twice the anticipated horizontal motion. Movements are dependent on the temperature extremes and the spacing between pads.

This bulletin is primarily dedicated to **building** or **structural isolation**. The nouns "pads" and "bearings" are interchangeable.

Rubber is an engineering material and design is based on both chemical and physical properties. Neoprene and Natural Rubber formulations fill both requirements. Neoprene has the advantage of better aging documentation and chemical resistance. Natural rubber is considerably less expensive and lower in dynamic stiffness. Natural Rubber aging documentation is not as formal, but with modern anti-oxidant and anti-ozonant additives, aging is no longer of major concern.

Load carrying capacity is based on:

1. Hardness
2. Area
3. Shape Factor
4. Allowable Strain
5. Allowable Stress

Durometer is the term for hardness as indicated by a Durometer number. The normal range for isolation is 40 to 60±5 as limited by dynamic stiffness. It is measured by a clock like instrument called a Durometer that has a spring loaded pin in the flat surface on the bottom. Penetration shows as a direct reading by a single hand that points to the hardness number. The harder the rubber, the higher the durometer and the greater the load carrying capacity.

Compression Area is the fully covered pad area at 90° to the supported load. In flat pads the **shear** area is identical. Shear offers horizontal resistance to wind and accidental impact from a derailed train or a large vehicle. Shear stiffness and spring back restores centering and contributes to stability.

Shape Factor: Rubber is similar to a fluid and volumetrically incompressible. When the flat surface is loaded and the rubber squeezed, the rubber bulges. The bulge volume is equal to the pad deflection multiplied by the loaded area. Shape Factor is defined as the loaded area divided by the bulge or escape area. While this is usually perimeter area only, holes or cutouts can be introduced to allow for inward bulging as well. Typically, the holes or ribs in standard isolation pads, such as the "Super W", are there to reduce shape factor.

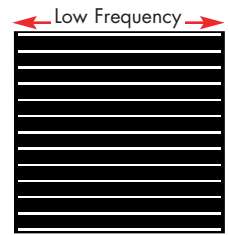

Seismic Isolation Bearing

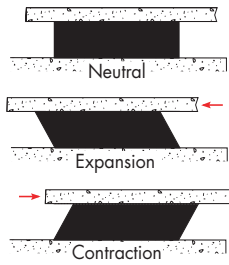

Shear Function



Isolation Bearing

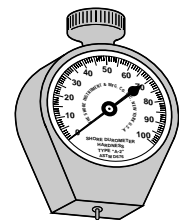

Durometer

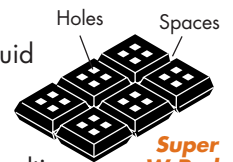

Super W Pad



The Shape Factor for a 12" x 12" x 1" thick pad (300mm x 300mm x 25mm) would be:

$$SF = \frac{A}{E} = \frac{\text{Loaded Area}}{\text{Escape Area}} = \frac{12 \times 12}{12 \times 4 \times 1} = \frac{144 \text{ in}^2}{48 \text{ in}^2} = 3$$

If the pad were 2" (50mm) thick, the SF would drop to 1.5 or should it be 0.75" (20mm), it would increase to 4.

The higher the SF the greater the capacity, as it is more difficult for the rubber to bulge.

Allowable Strain is the percentage reduction of the overall thickness. A 1" (25mm) thick pad compressed 0.10" (2.5mm) has a strain of 0.10/1.00 (2.5/25) or 10%. Strain should be kept very low when there are large variations in loadings and large shear displacements such as under bridges or trestles as this type of cycling leads to fatigue. Most engineering references consider strain more critical than stress.

Highway codes such as the British BS 6177 and the American AASHTO may limit pads to as little as 6% strain. Building isolation is more passive, so strain can be somewhat higher and subject to the designer's experience.

We have overloaded high quality pads in our laboratory to 60% strain (6-8 times rated load) and held them for a week. They recovered 80% to 90% of the original thickness immediately and 100% in a day. The recommended strain limit had been 15% for many, many years. We do not know if the more conservative numbers are based on negative experience or arbitrarily increasing safety factors.

Allowable Stress is the loading per unit area. Maximum published compressive stress values are as high as 3000psi (20,680 kPa), but more commonly 2000psi (13,790 kPa). A limit of 1500psi (10,340 kPa) in compression is recommended provided strain is in the 8-10% range. Reductions in either number increase consistent performance over time. Much lower stresses are often used to provide a practical bearing size when support areas are large and loadings low.

If a 10,000 lb (4545 kg) bearing pad were to be located under a 12 inch (300mm) beam flange or the load were applied at the top of a 12 inch (300mm) square column, we would use minimum 10" x 10" (250mm x 250mm) pads both for appearance and stability. Since there are 100 square inches, the stress drops to 100psi (689 kPa), nowhere near maximum design. Therefore, loadings may be controlled by available space, stability, common sense or aesthetics rather than maximum allowable stress.

Empirical Shape Factor curves help the designer. While they are based on durometer, results can vary widely as not only do Natural Rubber and Neoprene have different characteristics, but compounds of either have different moduli in compression and shear. Shape Factor curves are a valuable design tool and used to arrive at a reasonable design. Physical testing is essential for final tuning. In our laboratory we test pads up to 750,000 lb (340,000 kg) capacity and provide computerized load deflection curves in hard copy (see photos 10 & 11, page 8). The following illustration is a typical test curve.

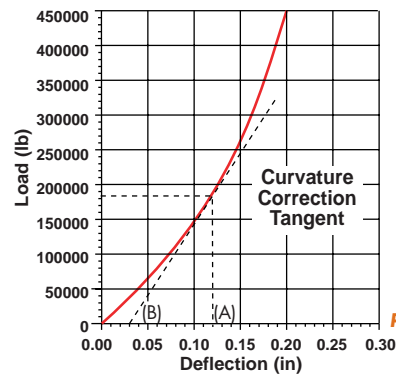

Effective Deflection
 0.12 Deflection (A)
 - 0.03 Correction (B)
 0.09 Usable Deflection for Frequency Calculation

Typical Load - Deflection Curve with Curvature Correction Calculation
 Pad Thickness 1-1/2" (38mm)

This is not a design manual but a general source of information as to bearing pad design. If our results differ from your experience, it is because of different references and compounds.

Earlier in our discussion we referenced a 12" x 12" (300mm x 300mm) pad in thicknesses of 2" (50mm), 1" (25mm) and 3/4" (20mm) with respective shape factors of 1.5, 3 and 4. Let us see how these pads would act by referring to the 60 durometer shape factor curves.

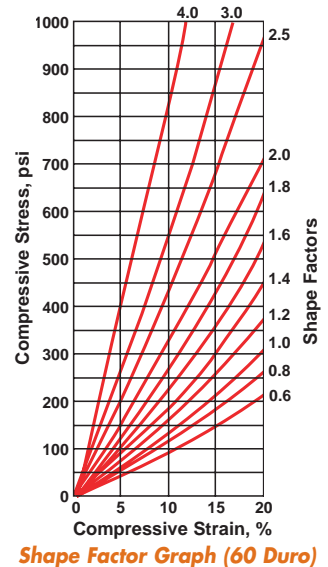

Pad Size (in)	SF	Area (sq. in.)	Stress @ 8% Strain (psi)	Deflection 0.08 x T (in)	Capacity Stress x A (lb)
12x12x2.0	1.5	144	170	0.16	24,480
12x12x1.0	3	144	450	0.08	64,800
12x12x3/4	4	144	660	0.06	95,040

When rubber bulges, it develops large shear forces at the upper and lower contact surfaces. If pancaking occurs, the shape factor curves become meaningless. Simple rubber pads used at low stress between rough concrete surfaces, do not spread in the contact area. As a rough guide based on our experience, 400psi (2757 kPa) between concrete surfaces and 250psi (1723 kPa) between dry steel surfaces are not a worry.



Simple Low Stress Rubber Pads

The 12" x 12" x 3/4" (300mm x 300mm x 20mm) pad at 660 psi (4550 kPa) with a shape factor of 4 does not fall into these categories. Therefore, steel plates must be bonded to each surface to prevent surface spreading. In most cases, these plates are 1/8" (3mm) thick and covered with 1/8" (3mm) bonded rubber top and bottom. There is a 1/4" (6mm) protective layer around the edges. The deflection of the 1/8" (3mm) cover is negligible as the shape factor jumps to 24, but the overall pad dimensions are now 12-1/2" x 12-1/2" x 1-1/4" (318mm x 318mm x 32mm).

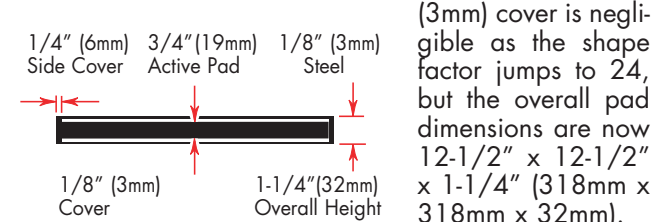

Assuming the loading of 95,040 lb (43,200 kg) is correct, but the deflection of 0.06" (1.5mm) is too low to meet a frequency requirement, we would increase the number of layers.

To attain 1/2" (13mm) deflection, the bearing would have eight 3/4" (19mm) active layers. The overall configuration would be nine 1/8" (3mm) bonded steel plates, 1/8" (3mm) top and bottom cover and 1/4" (6mm) protection on all sides. The overall dimensions would increase to 12-1/2" x 12-1/2" x 7-3/8" (318mm x 318mm x 187mm).

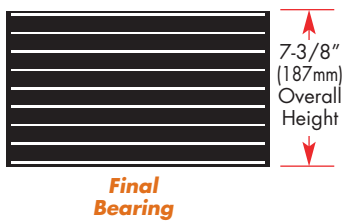

Loaded Bearing Showing Bulges Between Plates

There are many solutions to the problem. Shape factors are computerized so it is relatively simple to sample different solutions to arrive at the best engineering design. Designing manually from time to time is important to maintain perspective.

Our factory's capabilities include mold manufacturing and steel work in addition to rubber mixing and molding. We have a computerized test facility. Our professional engineering department designs pads both for frequency and capacity.

All rubber products are molded under tremendous pressures of about 1,000 pounds per square inch (6895 kPa). The pressure comes from the huge hydraulic press cylinders. Heat is provided by thermostatically controlled plates above and below the molds. The ideal temperature for vulcanization depends on the thickness and type of rubber, but it is usually about 305° F (152°C). Cure time is roughly one hour per inch of thickness.

SPRING ISOLATORS

Not all problems can be solved with rubber isolation pads. On page 2 we have indicated that the cut off point for rubber bearings is about 5.5 Hz. This would mean that the incoming frequency should not be lower than 16.5 Hz just to maintain the traditional but often unsatisfactory 90% theoretical efficiency. The efficiency equation is based on the assumption that a structure is a lumped mass or a block of concrete that has no flexibility and an infinite resonance frequency. It is also assumed that this rigid mass loads each isolator in accordance with the weight distribution as a lump mass at each location.

This assumption is false. Just as in the isolation of structural floors from machinery, the selection of a practical deflection is dependent on the sensitivity or rigidity of the structure and the various resonances of the structural elements. A lightly loaded structural floor might have a frequency as high as 7 Hz and fully loaded, 3 Hz. The frequency of the steel columns resting on the isolators might be very much higher. Concrete structures will transmit structurally induced noise over very large distances from the source with almost no attenuation.

We recently extended our own office building and some demolition was required. The construction workers were using small chipping hammers about 150 feet from my office. There was no air-borne sound transmission, but the structure-borne noise radiating from the ceiling made it seem like they were directly overhead.

In mechanical isolation work we have found that when isolating vibration at frequencies as high as 250 Hz, we have had to use air springs with a response of 3 Hz before the isolation was effective as the vibration was in the audible noise range.

Moving on to lower speed machinery at 30 Hz, we have had to use isolators with a response as low as 2 Hz (a frequency ratio of 15 to 1) before we could solve the problem.

We have been involved in a number of jobs where the acoustician recognized that not only did the building not respond as one mass, but that the requirements for isolation varied in different parts of the structure. The ground vibration dissipated with distance from the source, so lesser treatment would be satisfactory further from the railroad.

In one application, the building contained office space, a cinema and a live theater. The rest was a plaza over a garage. The critical area was supported on spring mountings with a response of 3.5 Hz and the plaza area on 7 Hz rubber bearings.

In another example, that portion of the building over the railroad tracks was supported on 2.5 Hz spring isolators. Further away spring deflections were smaller and the frequency 3.5 Hz. The extreme areas were supported on 6.5 Hz rubber bearings.



Train Passing Immediately Adjacent to Building Columns- Note Spring Isolation on Top of Column



Building Support Steel on 6.5 Hz Rubber Bearing Pads

While steel spring isolators do an excellent job of stopping vibration, it is very important that high frequency noise transmission is considered too. It is our suggestion that all spring isolators have 10 Hz base isolation pads 2" (50mm) thick, manufactured to the same standards as in the earlier part of this discussion.

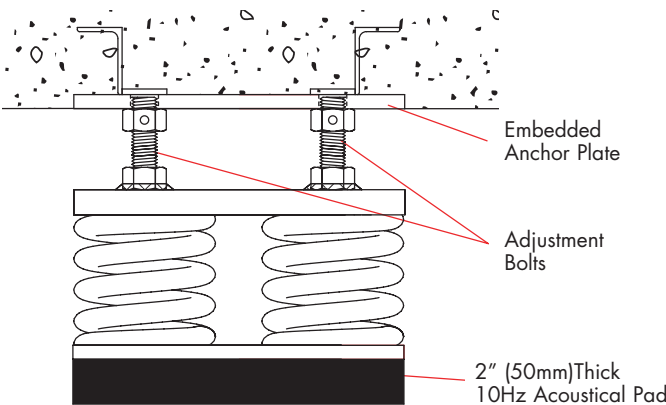

Type SLFJ Hydraulically Adjusted Spring Isolator

Spring mountings can be manufactured to any capacity. Practical designs have deflections of as much as 4" (100mm), which corresponds to a frequency of about 1.5 Hz. However, it is generally not practical to go to these numbers as the horizontal stiffness of the spring drops in proportion to the vertical and the building becomes more responsive to wind loads.

Another concern is the ratio of the dead and live loads of the structure. Live loads may be an additional 30% of dead load. If the mountings had a deflection of 3" (75mm) at dead load, it would increase to 3.9" (99mm) when fully occupied. This variation in elevation could be both a mechanical nuisance and undesirable. Therefore, we have not worked with deflections of more than 2" (50mm) at design loadings.

The consideration of specified deflection, and when this specified deflection occurs, is of major importance as it controls the isolation performance.

All structural engineers must design buildings to accommodate dead load plus the maximum conceivable live load. When specifying deflection for the isolators, whether they are rubber or spring, the acoustical engineer should specify the deflection needed to solve the acoustical problem at the lowest level of occupancy or live load when vibration and noise is a concern. If the deflection is specified at maximum load, there will be lesser deflection and lower efficiency most of the time. Basing acceptable performance on minimum loading

means the isolation will only improve at greater occupancy. However the mountings must have additional capacity to accept maximum structural loadings.

In designing spring isolators, travel can be limited beyond the most probable normal occupancy, by including limit stops. Stops parallel and bypass the springs so the load is transmitted to the lower isolation pads directly. There is an accepted loss in efficiency for those extreme structural design loadings that will probably never occur.

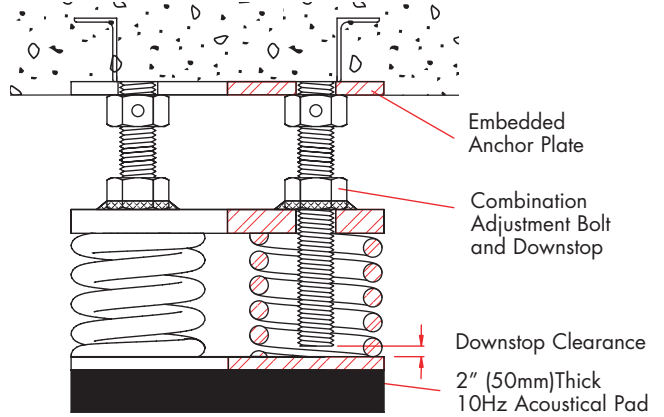

Type SLFJS Hydraulically Adjusted Spring Isolator with Downstop

There are a number of issues to be addressed in deciding on isolation technique. The first is **"Replaceability"**.

Even though highway specifications are very demanding, when rubber bridge bearing pads are used at buttresses or pylons to accept expansion and contraction or provide vibration isolation, they always remain accessible. Hydraulic jacks can be inserted next to the pads and the pads replaced.

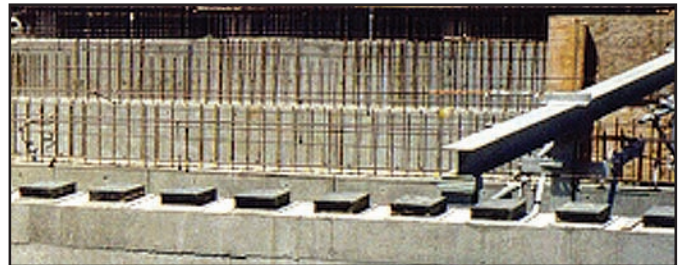

Leveled Isolation Pads Resting on Foundation Wall Prior to Continuing Construction

In isolating structures, this is not the general rule and pads are generally put in position and the structure proceeds. While we have no history of pads having gone bad and requiring replacement, we would suggest that if they are not made removable by using the same methods we will suggest a little further on for spring mountings, that there is provision for hydraulic jack pockets as needed. At some time, well beyond the lifetime of the architect, the structural engineer or the manufacturer, some future generation should not be left with an insoluble pad replacement problem. Lifting a structure a maximum of 0.4" (10mm) in the pad location and perhaps some immediate adjacent areas, is doable if provision is made for jacks.

Since pad deflections are always relatively small, their gradual deflection as the structure progresses is of little consequence. Spring mountings are an entirely different issue.

Spring specifications generally call for no less than 0.8" (10mm) deflection, and 2"(50mm) is not unusual. As the technique becomes more common, and either performance requirements or input more severe, it is possible that deflections could move into the 4" (100mm) range. It is not practical to have a structure change elevation during construction with numbers of this magnitude. Should the loadings not be added uniformly, the incomplete structure would suffer a change of level as well. Therefore, two methods are used to control the problem.

Precompressed Spring Assembly

The first consists of calculating the dead load at each location. The springs are precompressed to 70% of the dead load within a structural housing similar to a clamp, as shown in the illustration. Precompression is done in a hydraulic press and each bolt tightened to hold the proper share of the load when the press is released. The mounting is a rigid support up to this 70% loading. While this method has been used for quite some time, it has its shortcomings.

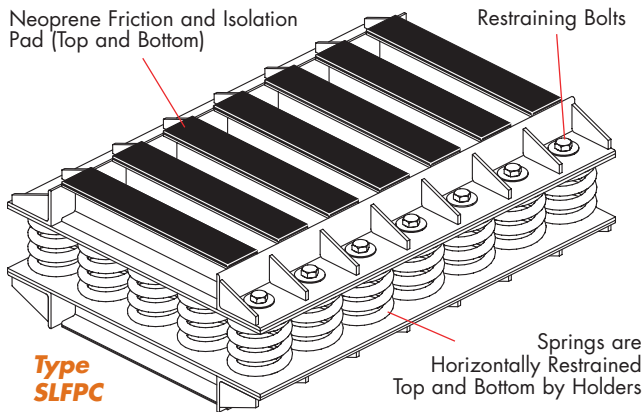

Structural weight calculations are broad. In terms of foundation design, normal discrepancies are of no consequence. However, when the structure is dependent on springs releasing themselves, if the weight is not close to the calculation, the springs will either release too early or not at all. Hot wound spring capacity can vary plus or minus 10%. Assuming they do release exactly as planned, there is still additional travel equal to 30% of the dead load deflection plus additional live load. A 2"(50mm) spring deflection example is easier to visualize. The mountings should release at 1.4" (36mm), depending on whether the 2"(50mm) was specified at dead load or at dead load with some occupancy. They would have to travel an additional 0.6"(15mm) or more at full load. This is considerable movement as it is not just the mountings that are moving, but the whole structure.

Should the total weight be correct, but the distribution erroneous, the mountings would release and continue traveling at different times. Most important the structure is at a fixed elevation only until 70% of the assigned load is reached. Thereafter the level changes. The final elevation can not be forecast as it is weight and exact spring rate dependent.

Should there be a need to change springs, the only way to do so is to tighten the bolts so the springs cannot expand, jack up the building slightly and pull the mountings out. Alternately, you might compress the springs

past the actual load by tightening the bolts. The loadings on these bolts are so high that realistically even with new clean bolts, this is all but impossible to do. Were you to do so, you would still have to establish temporary supports while removing and service the mounting.

While we do not refuse to manufacture these designs when specified by others, and do everything possible to make them user friendly, we much prefer the following approach.

Hydraulically Adjusted Spring Isolators

Many years ago we designed the SLRJ Mounting. They have structural steel sides with removable spacers on top that support equipment rigidly during erection. Because the equipment is held at elevation, water, electrical and other services can be completed without waiting for spring adjustment. If a mounting supports 25,000 lbs.(11364 kgs.) or more, we load the springs inside the housing with a hydraulic jack and run up the bolts on top of the spring plate to hold this adjustment. This procedure is followed all around the machine until the springs have been compressed sufficiently to retain the load and lift the equipment a few thousandths so the steel spacers can be removed. The bolts next to the jacks are advanced to hold this final adjustment and the jacks removed. The system is now spring supported without any change in elevation.

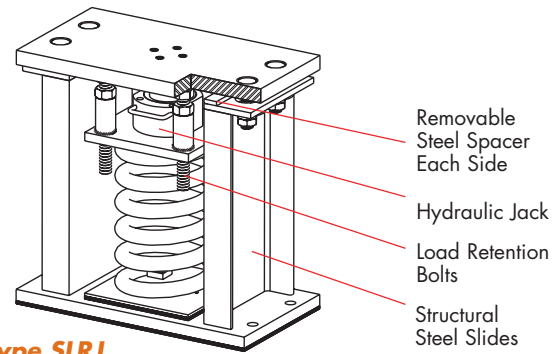

We use exactly the same system in supporting structures. The mountings can be built to any capacity, but the requirement for an individual isolator rarely exceeds 750,000 lbs.(340,000 kgs.) Rather than using steel sides to support the structure, temporary support is provided by concrete piers or individual steel stanchions.

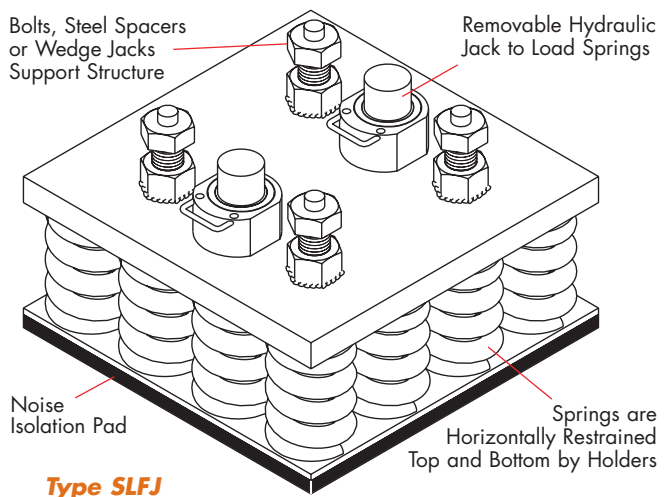

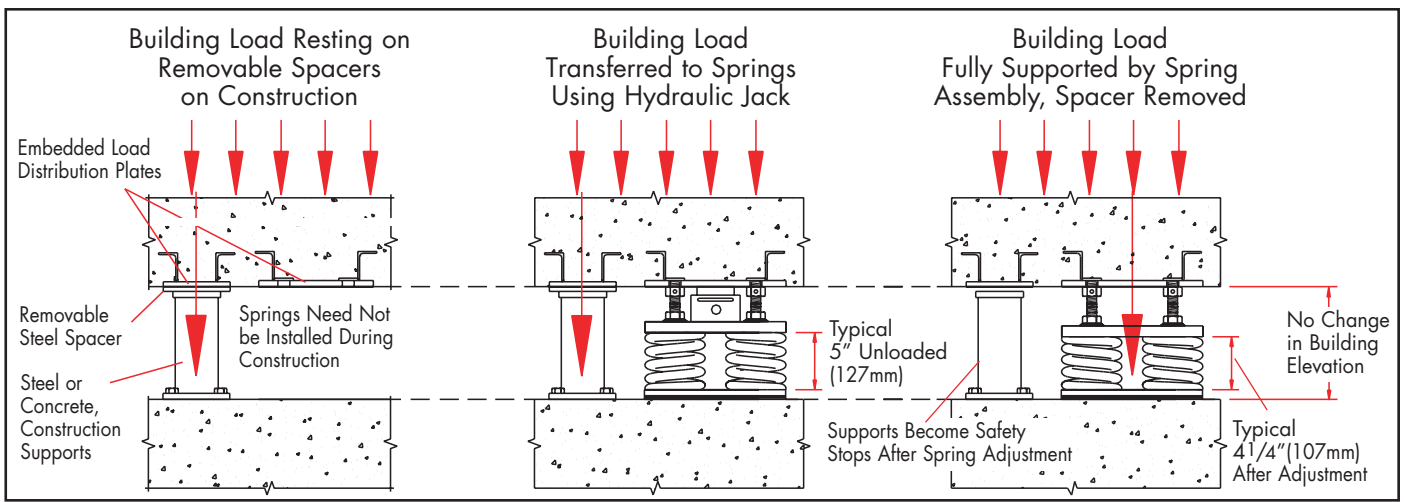

The building is held at fixed elevation by the stanchions plus the removable steel spacer on top until the building is completed. The building never moves during construction. Hydraulic jacks are then introduced to compress the springs uniformly, and the structural support bolts advanced, mounting by mounting, until the spacers can be removed. The elevation never changes. If the loads are not exactly correct, adjustments vary until each mount picks up the exact load at that location.

Should the architect wish to minimize live changes in elevation, spring adjustment could be held off until all mechanical systems were installed, or everything except the people.

Should the springs need servicing, the steel shims are put back in place, the springs relaxed by reversing the installation procedure until the mounting is completely free and the load back on the stanchion. Depending on location, the compression plate over the springs could be removed and the springs serviced with the lower base plate in

position. If it is more expeditious to do so, the whole mounting is removed, serviced, placed back in position, the load restored and the spacer removed. This is a fool-proof method.

Earlier in the discussion we had mentioned that should you wish to install rubber bearing pads and have them removable, the same technique could be used. The difference is that the rubber bearing would be load supporting rather than the springs.

Building isolation systems should not be used in seismic zones without a thorough study of the prevailing frequencies, accelerations and amplitudes. All building configurations must be studied for wind effects and there will be those occasions where viscous damping becomes important.

Our professional staff can offer designs and specifications. We would be pleased to work with your acoustical consultant or to introduce you to consultant firms to help establish the frequency criteria.

Spring Isolators Close to Railroad

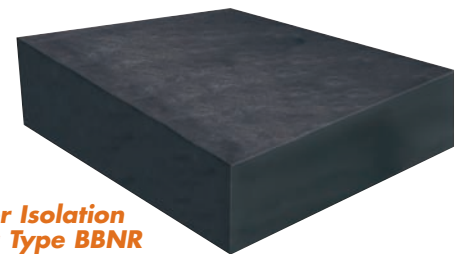

Rubber Isolation Bearing Type BBNR

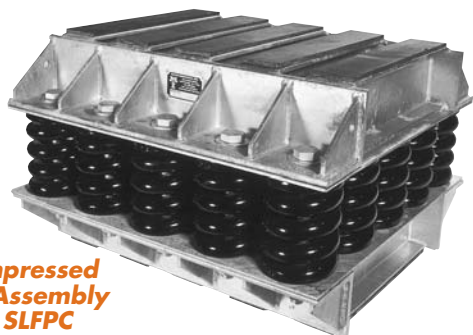

Precompressed Spring Assembly Type SLFPC



Subway Isolation Pads Under Carnegie Hall

[Click here to view sequence](#)

MOLDING ISOLATION BEARINGS

The following pictures will give you a better idea of the process of manufacturing isolation bearings. [Click](#)



1) Our certified welder is welding the steel mold shown in photograph 2. The steel components have already been saw or flame cut in other areas of the shop.



2) Completed mold for a 4" (100mm) bearing pad 18" x 24" (457 x 610mm). The mold has a base plate with 4 heavy keyed sides. The holes in the sides are for air escape and rubber flow as the uncured rubber is compressed. The closure plate is suspended temporarily. The mold is on a feed table to a huge rubber press with a 30" (762mm) cylinder and oil pressure of 3000psi (20,640 kPa). The closing force is over 2,000,000 lb. (909,090 kg.).

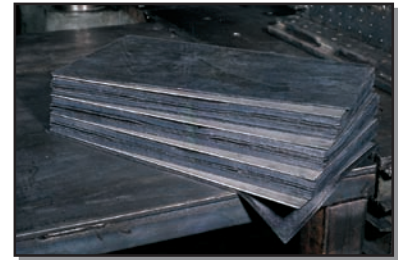

3) The uncured rubber is in layers separated by the bonded steel plates that maintain the shape factor. Starting from the bottom, the lower rubber cover, steel plate, and the active load bearing layer. The bearing consists of four plates, three load bearing layers and the top and bottom cover.



4) Our skilled pressman is placing the uncured rubber and sand-blasted steel plates, covered with a bonding agent in the mold. Two sides were removed to facilitate loading.



5) The mold is in the press during the slow, forceful closing. The mold will remain in the press for 3 hours at 305°F (152 °C).



6) The molding process is complete, and the mold back on the table. The excess rubber has escaped through the bleed holes.



7) The top and side plates are removed to reveal the finished part.



8) Flash rubber is removed around the edges, as well as the sprues from the bleeder holes.



9) A finished lot of bearings being wheeled to the test area.



10) Computerized testing in our 750,000 lb. (340,000 kg.) in house test machine to determine vertical spring rate and carrying capacity, supervised by our professional engineering staff.



11) Test in progress to determine shear characteristics under full vertical load. When independent testing is required, it is always witnessed by independent professional engineers.



12) Photograph at Multiplex, in Melbourne, Australia showing our building support pads after placement.

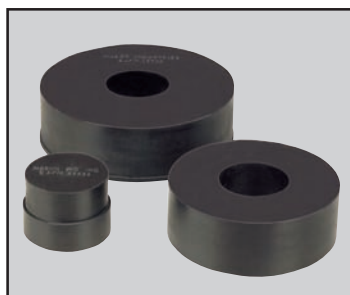

13) Simple all rubber isolation bearings used for train and underground track bed isolation as well as other applications.

We hope that you have found this bulletin interesting, and you have a better idea of the design of bearing isolation pads and spring mountings. Please call us whenever we can provide additional information or help with specific applications.

N. J. Mason

Norman J. Mason
President, Mason Industries, Inc.



MASON INDUSTRIES, INC.

350 Rabro Drive, Hauppauge, NY 11788 • 631/348-0282 • FAX 631/348-0279
2101 W. Crescent Ave., Suite D • Anaheim, CA 92801 • 714/535-2727 • FAX 714/535-5738
Email info@Mason-Ind.com or info@MasonAnaheim.com • Website www.Mason-Ind.com